

# EX-PROTECTED HUMIDITY AND TEMPERATURE TRANSMITTER



## RELIABLE MEASUREMENTS UNDER EXTREME CONDITIONS.

- Measurement of relative humidity and temperature, optional output of dew point and other calculated parameters
- Safe operation in areas with explosion risk
- Intrinsically safe probes
- Interchangeable stainless steel probes
- Robust aluminium housing



## TAKE A CLOSE LOOK: THE MAIN ADVANTAGES AT A GLANCE.

The new HygroFlex5-EX series is the latest development in two-channel transmitters for the exact measurement of humidity and temperature in explosive atmospheres. This device conforms to the latest international standards.

The HF5-EX series consists of a robust aluminium transmitter with or without display. The attached probes are cast into a stainless steel tube, and are certified for operation in Zone 0/20. The transmitter itself is certified for Zone 1/21.

### Functional display

- Measurement values with trend indicators
- Configuration via keypad possible

### Proven housing

- Robust, reliable aluminium housing
- Protection class IP66
- Wall or duct mount possible

### Power supply

- 10...28 VDC

### Outputs

- The two analogue outputs can be freely selected and scaled
- 2-wire (2 x 4...20 mA)

### Interchangeable probes

- Different probes can be connected to suit the application
- Easy calibration of the probes outside the explosive zone

### Explosion protection classes (gas and dust)

#### • Transmitter:

- Ex II 2(1) G Ex eb mb [ia Ga] IIC T5 Gb
- Ex II 2(1) D Ex tb [ia Da] IIIC T80 °C Db

#### • Probes:

HC2-SM-EX

- Ex II 1/2 G Ex ia IIC T5 Ga/Gb
- Ex II 1/2 D Ex ia IIIC T80 °C Da/Db

HC2-IM-EX / HC2-IE-EX

- Ex II 1/2 G Ex ia IIC T5-T4 Ga/Gb
- Ex II 1/2 D Ex ia IIIC T80 °C...110 °C Da/Db



### Easy configuration

- The configuration can be specified directly when ordering
- Configuration on site is also possible, using the HW4 software

# INTERCHANGEABLE STAINLESS STEEL PROBES.

Wall mounting

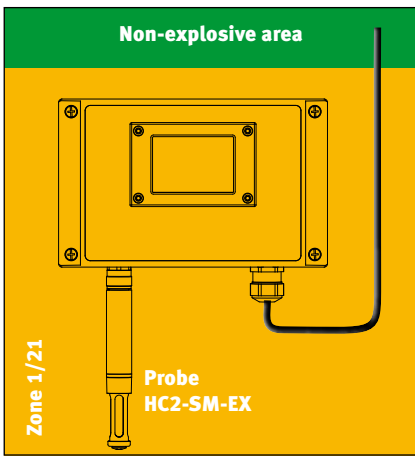

Duct mounting

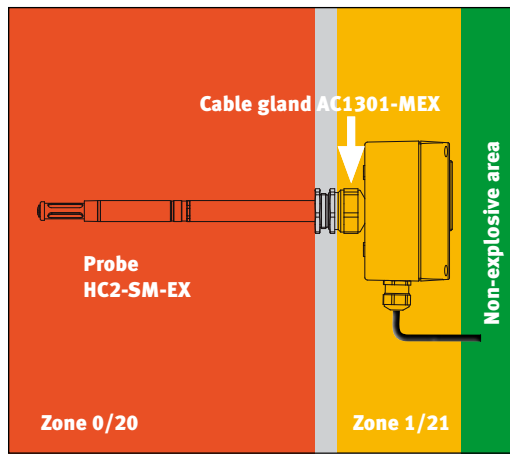

Cable probe for flexible installation

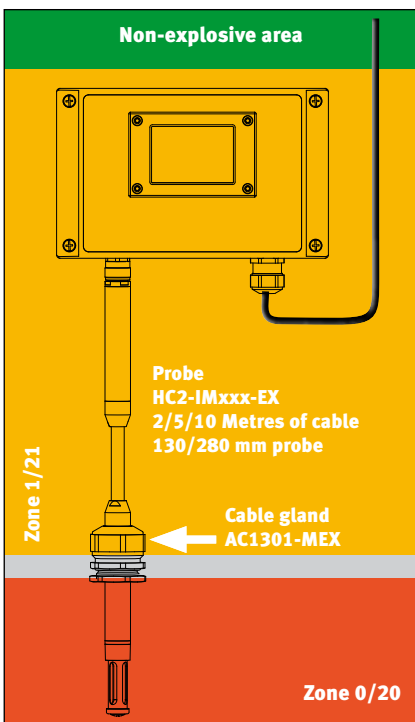

Screw-in cable probe for pressure pipe or low dew point

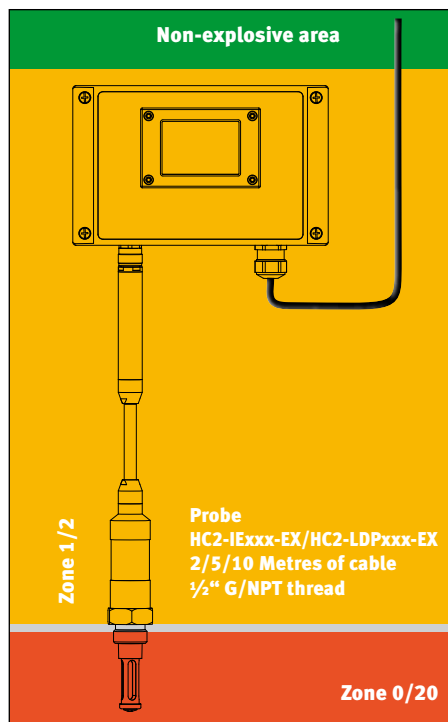

# TECHNICAL INFORMATION.

## HF520-EX-W

Wall mounted version (W)

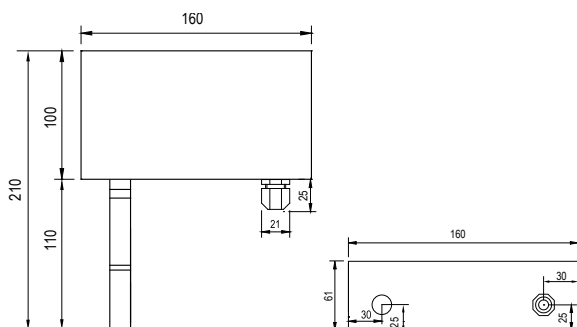

## HF520-EX-D

Duct mounted version (D)

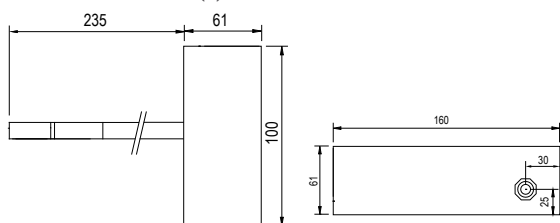

## HC2-SM-EX

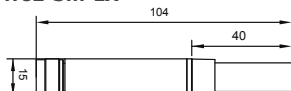

## HC2-IMxxx-EX

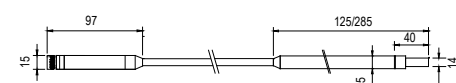

## HC2-IExxx-EX / HC2-LDPxxx-EX

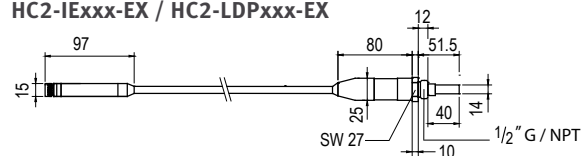

Identification EX North America
Class I, Div 1/2, Groups ABCD T5...T4,
Class II, Div 1/2, Groups EFG T80 °C...T110 °C
Ex e mb [ia Ga] IIC T5...T4 Ga/Gb
Ex tb [ia Da] IIIC T80 °C...T110 °C Da/Db
Class I, Zone 0/1, AEx e mb [ia Ga] IIC T5...T4 Ga/Gb
Class II, Zone 20/21, AEx tb [ia Da] IIIC T80 °C...T110 °C Da/Db

## HF520-EX

General	
Parameters	Humidity and temperature
Calculated parameters	All psychrometric parameters available
Housing material / Protection	Aluminium (DIN EN 1706 EN AC-AISI 12 (Fe)) / IP66
Weight	Wall mounted version: 1030 g Duct mounted version: 1140 g
Start-up time	Standard cold <60 s / warm <30 s
Measurement interval	20...240 s
Display	Optional, LCD without backlight
Electrical connections	Connections: Ex-e terminals (0.2...2.5 mm <sup>2</sup> ) Cable gland: 16 x 1.5 (Ø cable 4.5...7 mm)
Power supply	10...28 VDC
Current Consumption	2x24 mA start up / 2x20 mA operation
Application temperature	-40...60 °C without display
Housing / electronics	-10...60 °C with display
Service interface	UART internal service interface (only to be used outside the explosive zone)
CE / EMC compatibility	EMC Directive 2014/30/EU
ATEX directives	2014/34/EU (ATEX) CSA22.2, UL 508
Identification EX	⚠ II 2(1) G Ex eb mb [ia Ga] IIC T5 Gb ⚠ II 2(1) D Ex tb [ia Da] IIIC T80 °C Db
Analogue output	
Number	2
Current	4...20 mA, two-wire
Galvanic isolation	Yes
Maximum load	500 Ohms
Accuracy at 23 °C	<20 uA

## HC2-SM-EX / HC2-IM-EX / HC2-IE-EX / HC2-LDP-EX

General	
Parameters	Humidity and temperature
Housing material / Protection	Stainless steel / IP66
Cable lengths	2/5/10 metres
Identification EX	⚠ II 1/2 G Ex ia IIC T5...T4 Ga/Gb ⚠ II 1/2 D Ex ia IIIC T80 °C ...T110 °C Da/Db
Humidity measurement	
Sensor	HC2-SM/IM/IE-EX: ROTRONIC HYGROMER® IN-1 HC2-LDP-EX: ROTRONIC HYGROMER® LDP-1
Adjustment	Not via device menu (only outside the explosive zone with HW4 + AC3001)
Measurement range	0...100 %RH
Accuracy at 23 °C	0.8 %RH
Temperature measurement	
Sensor	HC2-SM/IM/IE-EX: Pt100 Class A HC2-LDP-EX: Pt1000 1/3 Class B
Measurement range	-40...60 °C or -40...85 °C
Accuracy at 23 °C	0.1 K

## Accessories

Filters	Steel sinter filter, SP-FN15
Cable gland	AC1301-MEX for duct mounting and cable probes (IM)

Would you like more information (special applications, ordering codes, etc.)? You will always find an up-to-date overview of the HygroFlex5-EX series on our Internet site at [www.rotronic.com](http://www.rotronic.com).

**rotronic**  
MEASUREMENT SOLUTIONS

ROTRONIC AG, Grindelstrasse 6, CH - 8303 Bassersdorf, Tel. +41 44 838 11 44, [www.rotronic.ch](http://www.rotronic.ch)  
 ROTRONIC Instruments (UK) Ltd, Crompton Fields, Crompton Way, Crawley, West Sussex, RH10 9EE, UK, Phone +44 (0)1293 571000, [www.rotronic.co.uk](http://www.rotronic.co.uk)  
 ROTRONIC Instrument Corp, 135 Engineers Road, Hauppauge, NY 11788, USA, Phone, +1 631 427-3898, [www.rotronic-usa.com](http://www.rotronic-usa.com)  
 ROTRONIC Canada Inc., 236 Pritchard Rd, Unit 204, Hamilton, ON, Canada, L8W 3P7, Phone + 1 416-848-7524, [www.rotronic.ca](http://www.rotronic.ca)  
 ROTRONIC Instruments Pte. Ltd., 1003 Bukit Merah Central, #06-31 Inno Centre, Singapore 159836, Phone +65 6376 2107, [www.rotronic.sg](http://www.rotronic.sg)